



Republic of the Philippines  
Province of Ilocos Norte  
**MUNICIPALITY OF MARCOS**

**SUPPLEMENTAL BID BULLETIN NO.1**

**AMENDMENTS TO THE BIDDING DOCUMENTS**

01-19-2023

This Supplemental Bid Bulletin is being issued to amend Invitation to Bid (IB 2023-001 Goods) of the Bidding Documents for the Project **Procurement and Installation of Furnitures and Fixtures to Different Offices in the New Three Storey Multi-Purpose Building**. Below are the following amendments:

ORIGINAL			AMENDMENT
<b>Delivery Schedule: (Sec. I Invitation to Bid p.8); (Sec. VI Schedule of Requirements p.30)</b>			
Fifteen (15) Calendar Days			Thirty (30) Calendar Days
<b>Specifications: (Sec. VI Schedule of Requirements pp.30-31); (Technical Specifications pp.36-38)</b>			
<i>Item / Service</i>	<i>Maximum Quantity</i>	<i>Technical Specifications / Scope of Work</i>	<b>FURTHER SPECIFICATIONS (SEE ATTACHED ANNEX A)</b>
1	13 set	Executive Desk/Table	
2	13 set	Executive Chair	
3	36 set	Visitor's Chair	
4	48 set	Office Desk	
5	180 set	Office Revolving Chair/Working Chair/Conference Chair	
6	40 set	Workstation Table	
7	10 set	Three (3) Seating Stainless Gang Chair	
8	10 set	Four (4) Seating Stainless Gang Chair	
9	1 set	Working Table (4-seater)	

10	5 set	Conference Table (6-seater)
11	1 set	Conference Table (8-seater)
12	1 set	Conference Table (10-seater)
13	1 set	Conference Table (17-seater)
14	1 set	Filing Room Shelves - BAC OFFICE
15	1 set	Filing Room Shelves - BUDGET OFFICE
16	1 set	Filing Room Shelves - HR OFFICE
17	1 set	Filing Room Shelves - ACCOUNTING OFFICE
18	1 set	Filing Room Shelves - PLANNING OFFICE
19	1 set	Filing Room Shelves (30 shelves) - ENGINEERING OFFICE
20	1 set	Filing Room Shelves - MAYOR'S STAFF OFFICE
21	1 set	Filing Room Shelves - GSO/PESO OFFICE
22	1 set	Filing Room Shelves - MDRRM OFFICE
23	1 set	Filing Room Shelves - TREASURY OFFICE
24	1 set	Filing Room Shelves - ASSESSOR OFFICE
25	1 set	Filing Room Shelves - CIVIL REGISTRAR OFFICE
26	1 set	Filing Room Shelves - AGRICULTURE OFFICE

27	1 set	Filing Room Shelves - MSWD OFFICE
28	1 set	Pantry - BAC OFFICE
29	1 set	Pantry - BUDGET OFFICE
30	1 set	Pantry - HR OFFICE
31	1 set	Pantry - ACCOUNTING OFFICE
32	1 set	Pantry - PLANNING OFFICE
33	1 set	Pantry - ENGINEERING OFFICE
34	1 set	Pantry - MAYOR'S STAFF OFFICE
35	1 set	Pantry - GSO/PESO OFFICE
36	1 set	Pantry - MDRRM OFFICE
37	1 set	Pantry - TREASURY OFFICE
38	1 set	Pantry - ASSESSOR OFFICE
39	1 set	Pantry - CIVIL REGISTRAR OFFICE
40	1 set	Pantry - AGRICULTURE OFFICE
41	1 set	Pantry - MSWD OFFICE
42	8 set	Transaction Table (1-seater)
43	3 set	Transaction Table (2-seater)
44	1 set	Transaction Table (3-seater)
45	2 set	Transaction Table (5-seater)



46	1 unit	Vault Room Enclosure	
47	1 unit	Mayor's Desk	
48	1 unit	Mayor's Chair	
49	1 unit	Mayor's Visitor Chair	



Please be guided accordingly.

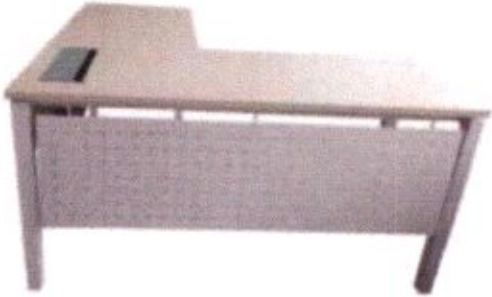

**SGD. ENGR. MARIELLE MENOR**  
Chairperson, Bids and Awards Committee



# ANNEX A

## TECHNICAL SPECIFICATIONS

No	Item Description	Qty	Unit
1	<p><b>Executive Desk/Table</b></p> <ul style="list-style-type: none"> <li>▪ L-shaped Table with HPL tabletop (machine pressed) and metal front panel with metal steel frame</li> <li>▪ Metal Finish: White</li> <li>▪ Modesty Panel Finishes: MFC</li> <li>▪ Size: 150cm W x 70cm D x 75cm H / 100cm W x 45cm D x 75cm H</li> </ul> 	13	sets
2	<p><b>Executive Chair</b></p> <ul style="list-style-type: none"> <li>▪ Mesh Chair</li> <li>▪ 340mm Nylon 5-star Base Headrest Adjustment</li> <li>▪ Adjustable Lumber Support</li> <li>▪ Adjustable Arms</li> <li>▪ Seat &amp; Back Tilt with Upright Lock</li> <li>▪ Nylon Castors</li> <li>▪ With Certificate of EN1335-2 (Safety)</li> </ul> 	13	sets
3	<b>Visitor's Chair</b>	36	sets

	<ul style="list-style-type: none"> <li>▪ Stackable Plastic Chair with Metal Sled Leg</li> <li>▪ Color: Black</li> </ul> 		
4	<p><b>Office Desk</b></p> <ul style="list-style-type: none"> <li>▪ Metal Legs with Customized Tabletop (Machine Pressed) in PVC Edge board</li> <li>▪ With Metal front panel and legs</li> <li>▪ Color: Beige Legs + Light Gray tabletop</li> <li>▪ Size: 150cm L x 70cm D x 75cm H</li> </ul> 	48	sets
5	<p><b>Office Revolving Chair / Working Chair / Conference Chair</b></p> <ul style="list-style-type: none"> <li>▪ Medium Back Chair</li> <li>▪ Black nylon frame, nylon armrest, nylon base/ Mesh backrest with high density, molded foam seat</li> <li>▪ Size: 58cm W x 64cm D x 93cm H</li> </ul> 	180	sets
6	<p><b>Workstation Table</b></p>	40	sets

	<ul style="list-style-type: none"> <li>▪ 2-seater side by side workstation with tabletop in HPL Finish (to be chosen) machine pressed</li> <li>▪ PVC edge boards</li> <li>▪ White Metal Leg Base</li> <li>▪ Size: 120cm W x 60cm D per table</li> </ul>		
7	<p><b>Three (3) Seating Stainless Gang Chair</b></p> 	10	sets
8	<p><b>Four (4) Seating Stainless Gang Chair</b></p> 	10	sets
9	<p><b>Working Table (4-seater)</b></p>	1	set

	<ul style="list-style-type: none"> <li>▪ Meeting Table with MFC Tabletop (machine pressed) with 1-piece 400mm one side two-layer groove wire management</li> <li>▪ Size: 1800mm x 1200mm</li> <li>▪ White Frame</li> </ul> 		
10	<p><b>Conference Table (6-seater)</b></p> <ul style="list-style-type: none"> <li>▪ Meeting Table with MFC Tabletop (machine pressed) with 1-piece 400mm one side two-layer groove wire management</li> <li>▪ Size: 1800mm x 1200mm</li> <li>▪ White Frame</li> </ul> 	5	set
11	<p><b>Conference Table (8-seater)</b></p> <ul style="list-style-type: none"> <li>▪ Meeting Table with MFC Tabletop (machine pressed) with 2-pieces 400mm one side two-layer groove wire management</li> <li>▪ 4 pcs 1100mm x 600mm Wire Tray</li> <li>▪ Size: 1800mm x 0.90mm</li> <li>▪ White Frame</li> </ul> 	1	set
12	<p><b>Conference Table (10-seater)</b></p>	1	Set



	<ul style="list-style-type: none"> <li>▪ Meeting Table with MFC Tabletop (machine pressed) with 2-pieces 400mm one side two-layer groove wire management</li> <li>▪ 4 pcs 1100mm x 600mm Wire Tray</li> <li>▪ Size: 1800mm x 1200mm</li> <li>▪ White Frame</li> </ul>		
13	<p><b>Conference Table (17-seater)</b></p> <ul style="list-style-type: none"> <li>▪ Meeting Table with MFC Tabletop (machine pressed) with 17-pieces 400mm one side two-layer groove wire management</li> <li>▪ 16 pcs 1100mm x 600mm Wire Tray</li> <li>▪ Size: 3300mm x 1200mm (per table)</li> <li>▪ White Frame</li> </ul> 	1	Set
14	<b>Filing Room Shelves – BAC OFFICE</b>		

- Marine Plywood, Machine Pressed 3/4" Thick
- Plastic Laminate, Wood Grain

1

Set

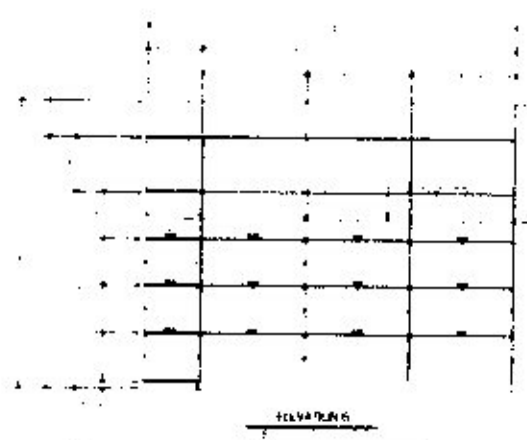
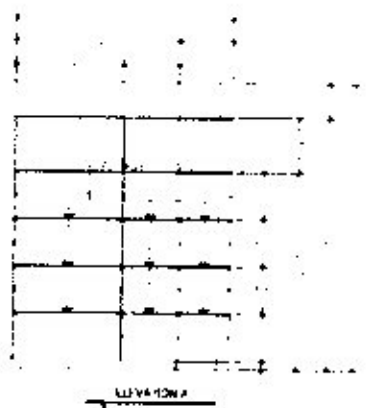
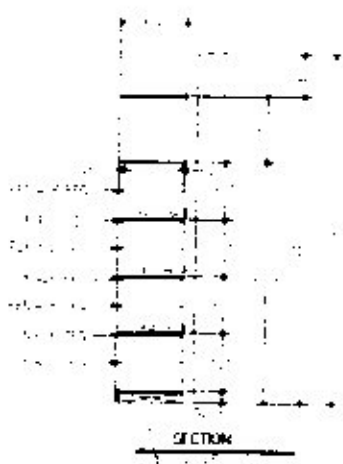
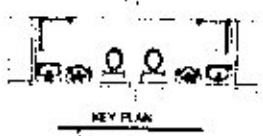

15 Filing Room Shelves - BUDGET OFFICE

1

set

- Marine Plywood, Machine Pressed 1/2" Thick
- Plastic Laminate, Wood Grain

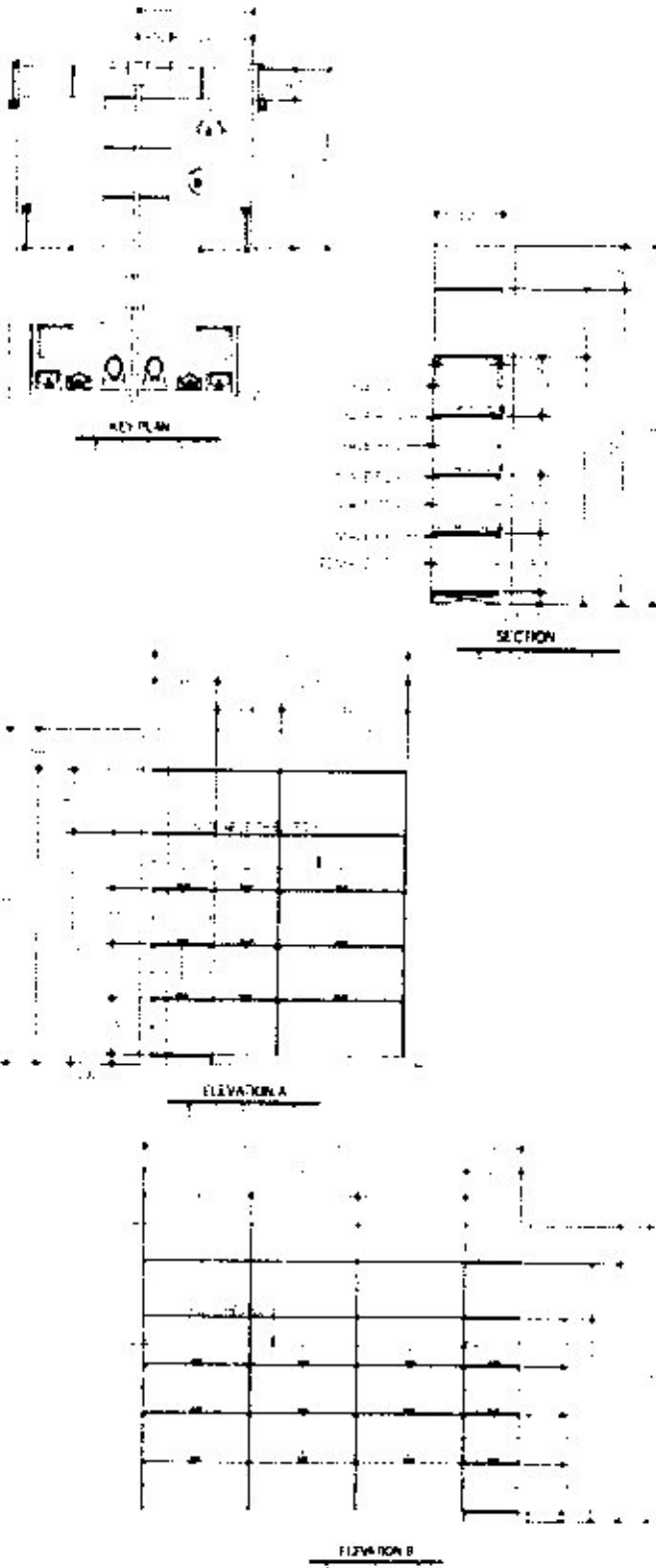

15 Filing Room Shelves - HR OFFICE

- Marine Plywood, Machine Pressed 3/4" Thick
- Plastic Laminate, Wood Grain

1

set

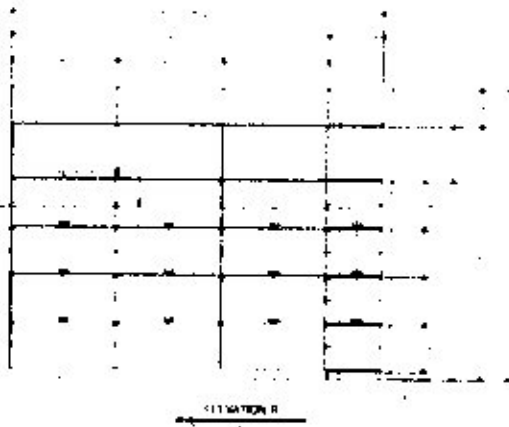
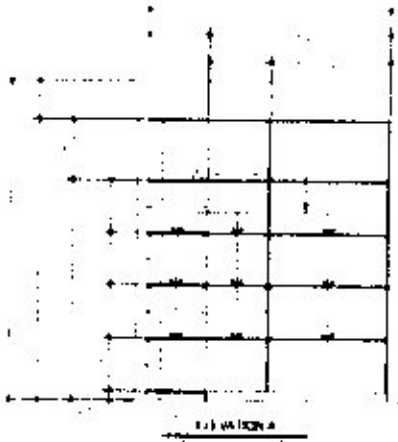

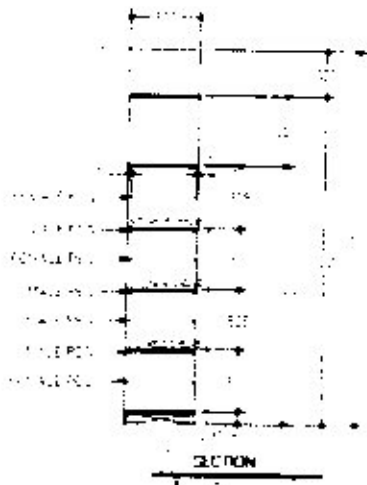

17 Filing Room Shelves - ACCOUNTING OFFICE

1

set

- Marine Plywood, Machine Pressed 3/4" Thick
- Plastic Laminate, Wood Grain



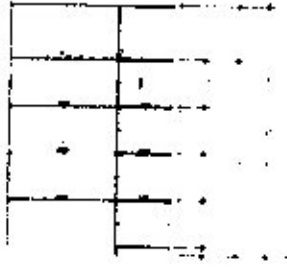

FIGURE 1

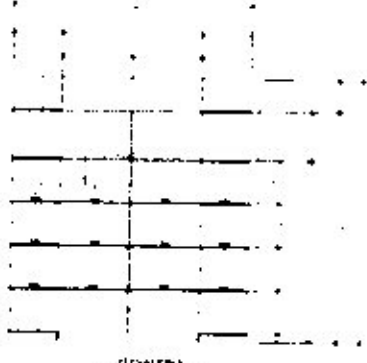

FIGURE 2

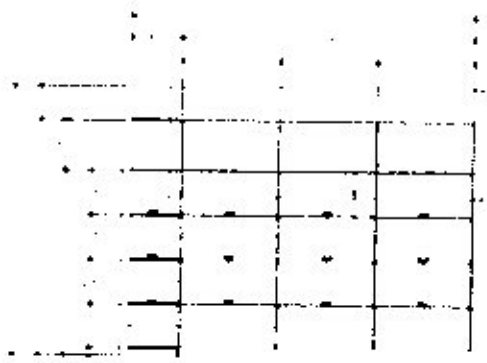

FIGURE 3

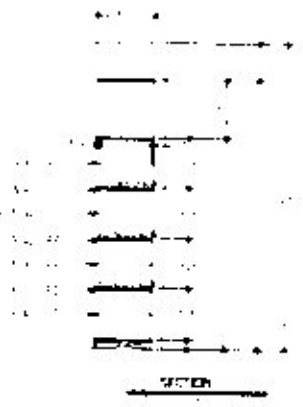

FIGURE 4

18 Filing Room Shelves - PLANNING OFFICE

- Marine Plywood, Machine Pressed 3/4" Thick
- Plastic Laminate, Wood Grain

1

6el

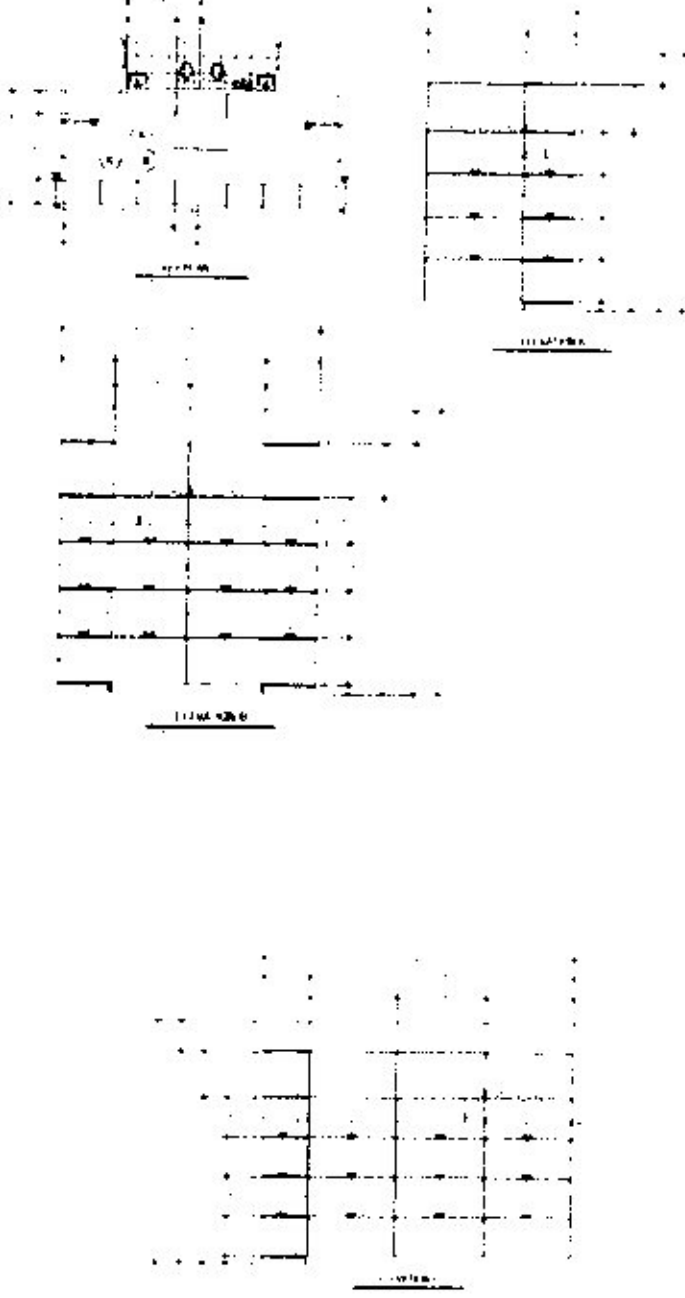

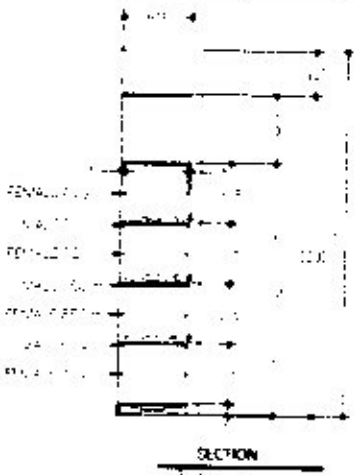
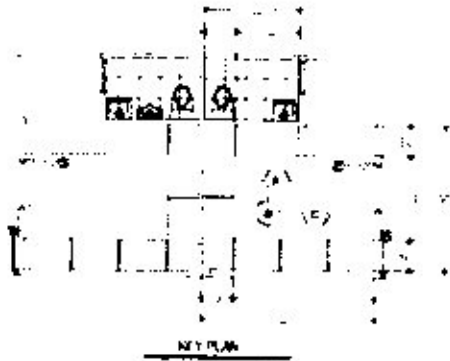
			
19	<p><b>Filing Room Shelves – ENGINEERING OFFICE (30-shelves)</b></p> <ul style="list-style-type: none"> <li>• Marine Plywood, Machine Pressed 3/4" Thick</li> <li>• Plastic Laminate, Wood Grain</li> </ul> 	1	set



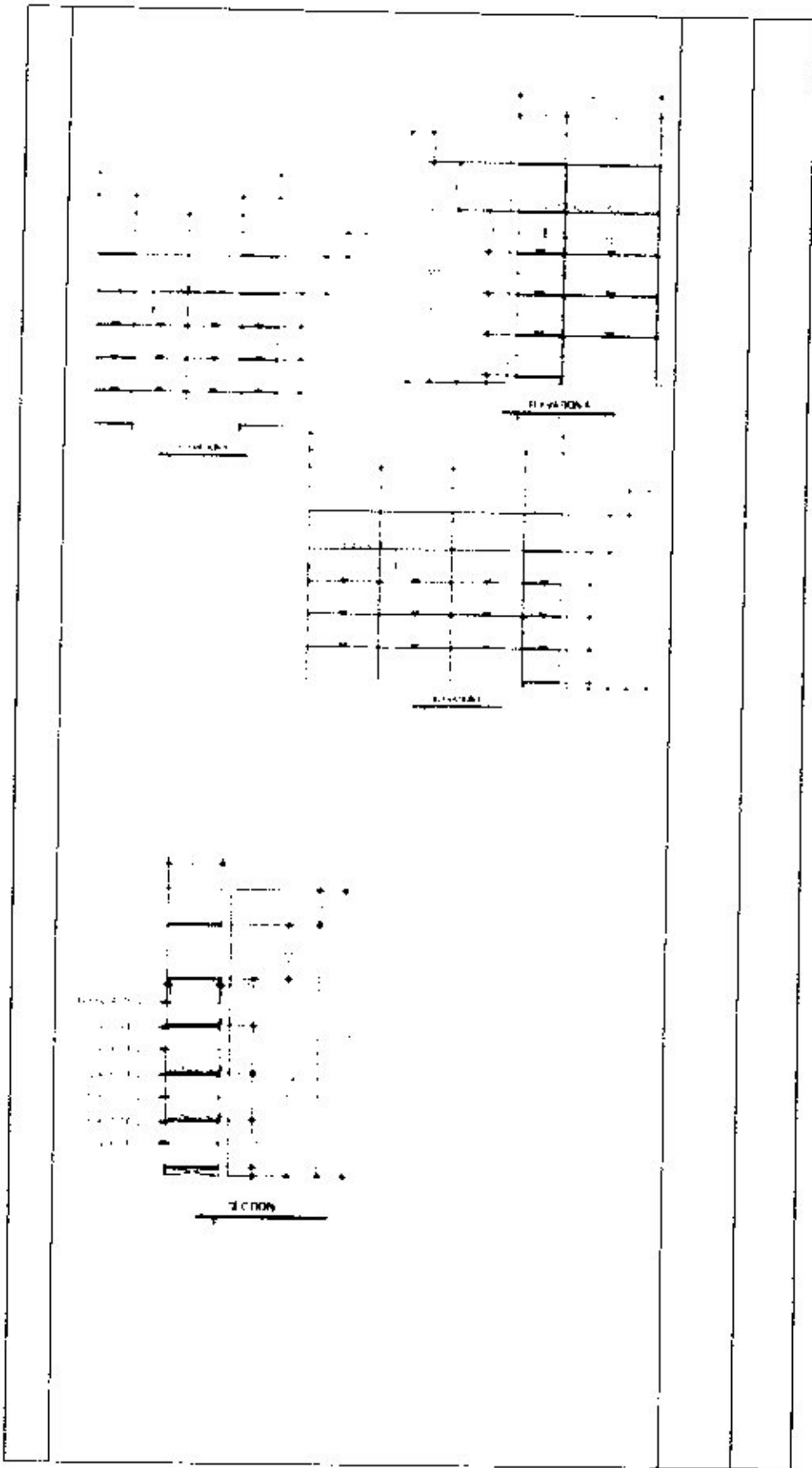

20 **Filing Room Shelves - MAYOR'S STAFF OFFICE**

- Marine Plywood, Machine Pressed 3/4" Thick
- Plastic Laminate, Wood Grain

1

set

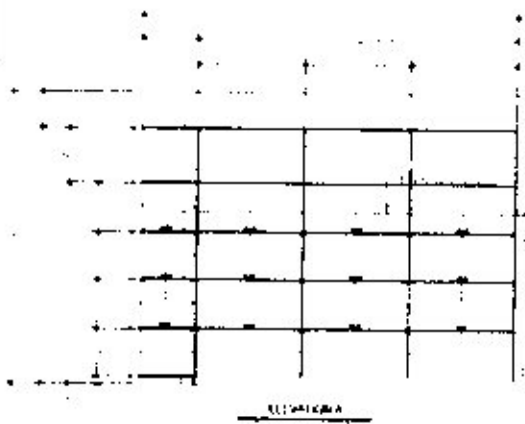
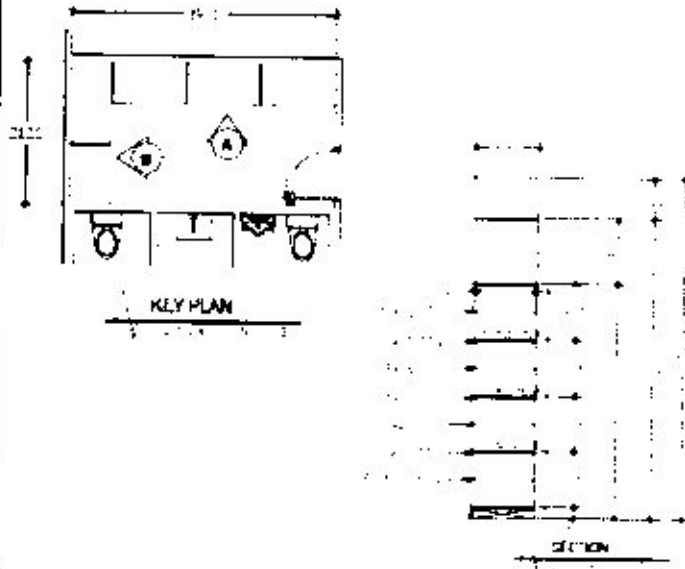

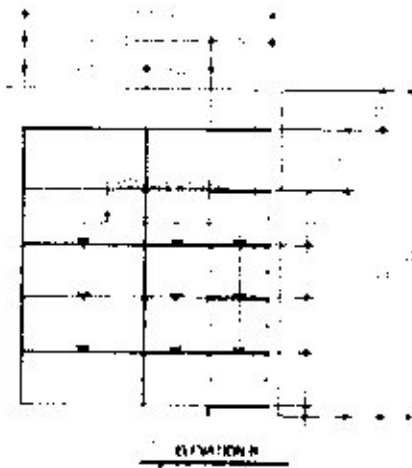

21 **Filing Room Shelves – GSO/PESO OFFICE**

- Marine Plywood, Machine Pressed 3/4" Thick
- Plastic Laminate, Wood Grain

↑

581

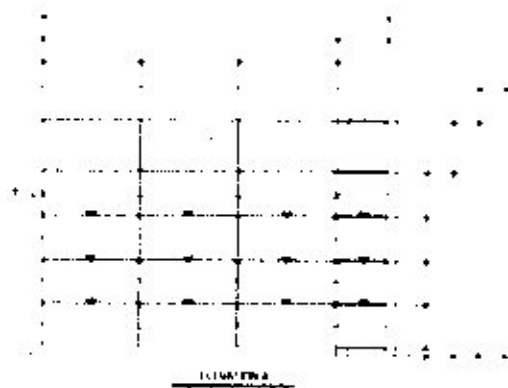
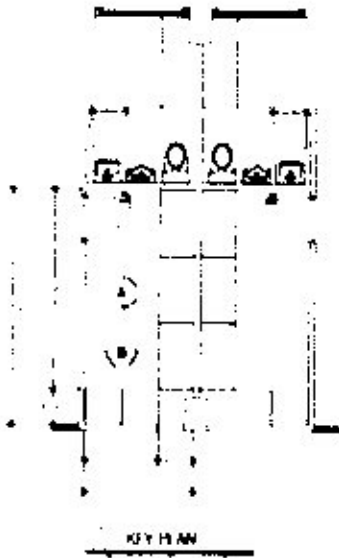

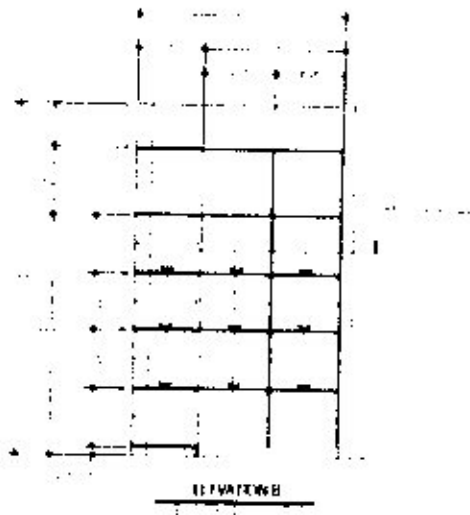

**22 Filing Room Shelves - MDRRM OFFICE**

- Marine Plywood, Machine Pressed 3/4" Thick
- Plastic Laminate, Wood Grain

1

set

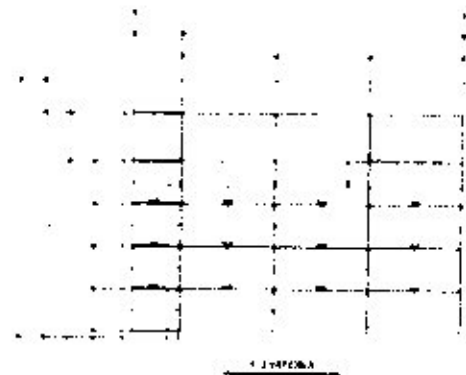

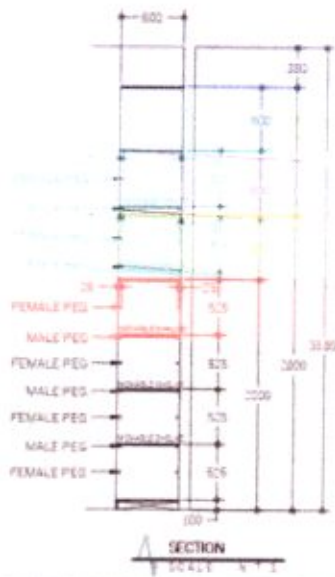
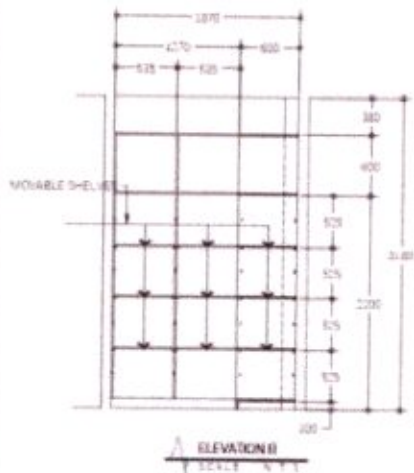

**23 Filing Room Shelves – TREASURY OFFICE**

- Marine Plywood, Machine Pressed 3/4" Thick
- Plastic Laminate, Wood Grain

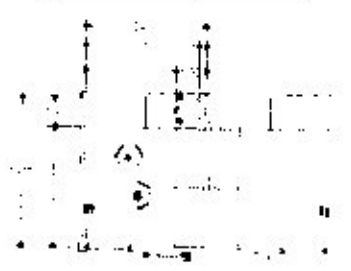

KEY PLAN

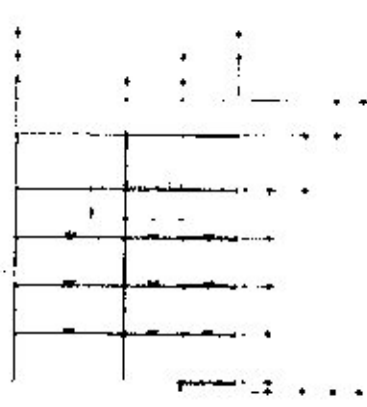

ELEVATION A

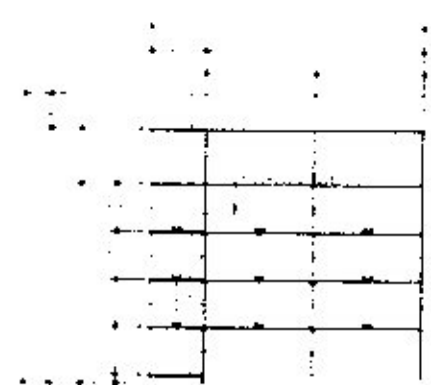

ELEVATION B

1

set

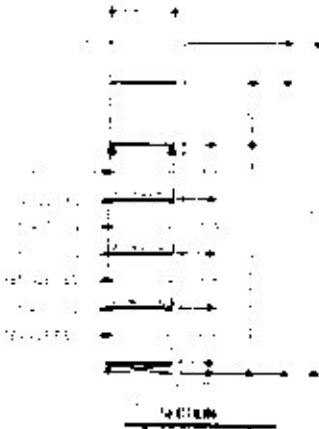
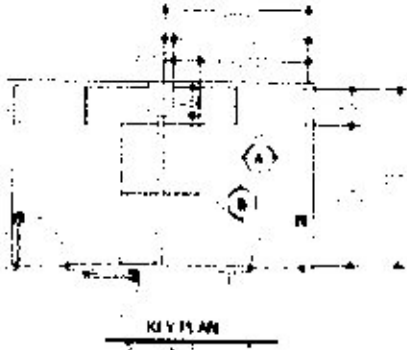
	 <p style="text-align: center;">KIVPLAN</p>		
24	<p><b>Filing Room Shelves – ASSESSOR OFFICE</b></p> <ul style="list-style-type: none"> <li>▪ Marine Plywood, Machine Pressed 3/4" Thick</li> <li>▪ Plastic Laminate, Wood Grain</li> </ul>  <p style="text-align: center;">KIVPLAN</p>	1	set

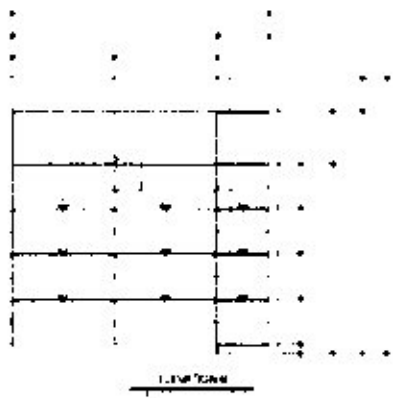
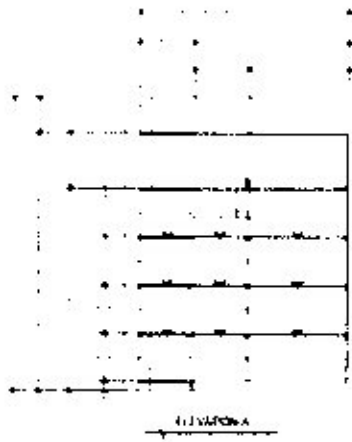



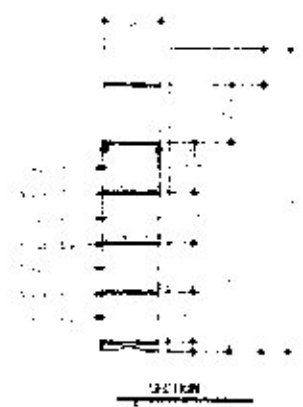

25 **Filing Room Shelves – CIVIL REGISTRAR OFFICE**

- Marine Plywood, Machine Pressed 3/4" Thick
- Plastic Laminate, Wood Grain

1

601

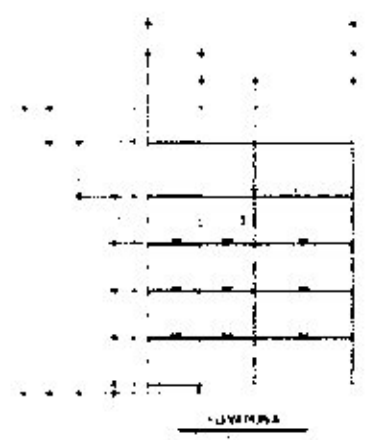
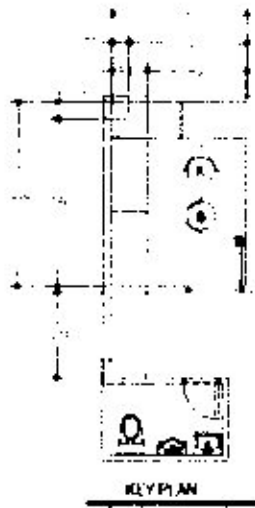

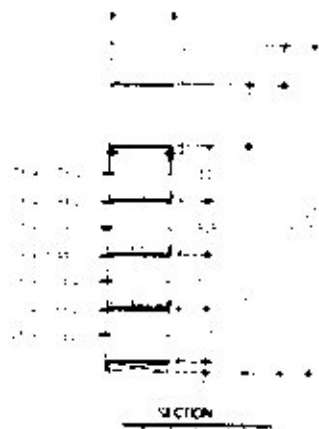
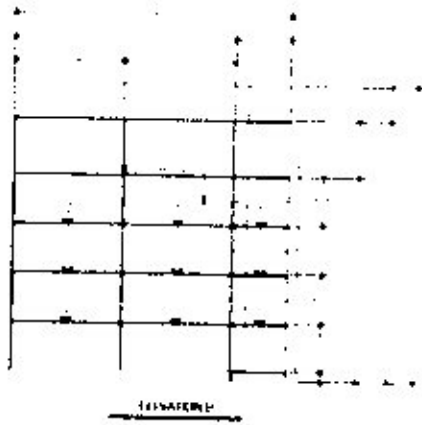

26 **Filing Room Shelves - AGRICULTURE OFFICE**

- Marine Plywood, Machine Pressed 3/4" Thick

Plastic Laminate, Wood Grain

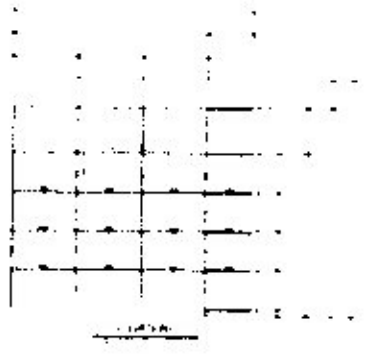
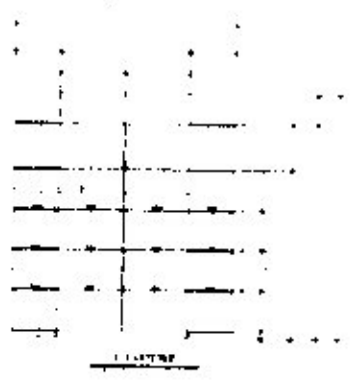
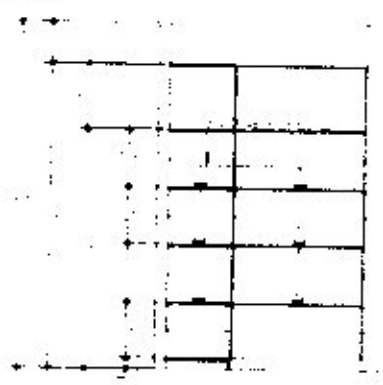
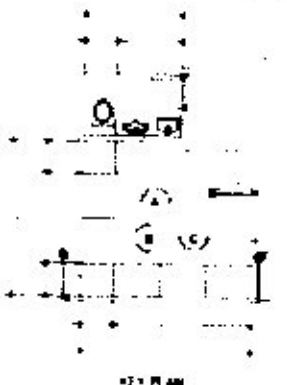

1 set

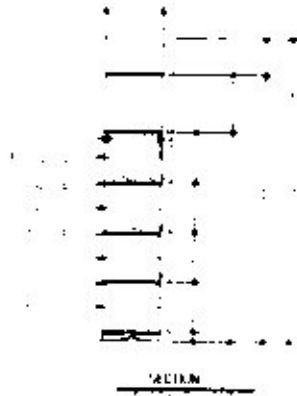

27 Filing Room Shelves - MSWD OFFICE

- Marine Plywood, Machine Pressed 3/4" Thick
- Plastic Laminate, Wood Grain

1 set

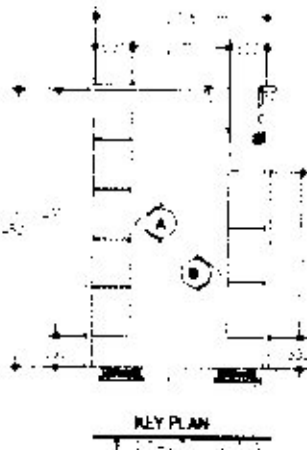

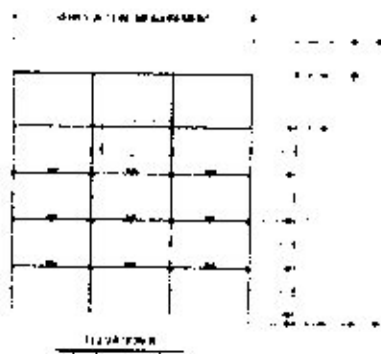
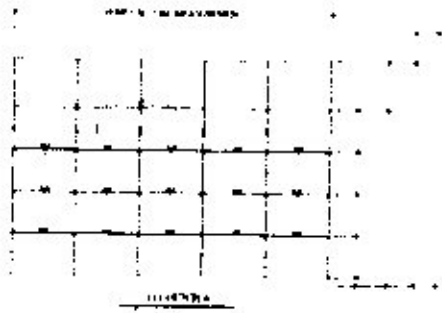

28

**PANTRY – BAC OFFICE**

- Marine Plywood Machine Pressed, 3/4" Thick
- Plastic Laminated, Wood Grain
- Granite Top, Jet Black

1

set

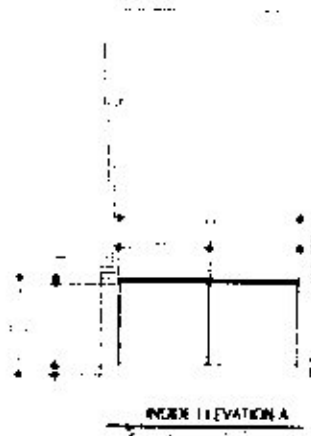
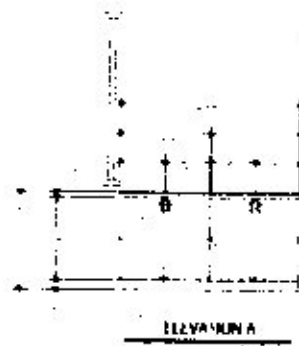

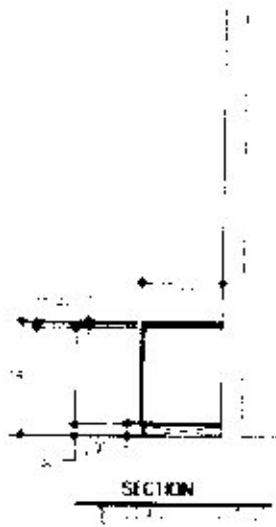

29 PANTRY - BUDGET OFFICE

- Marine Plywood Machine Pressed, 3/4" Thick
- Plastic Laminated, Wood Grain
- Granite Top, Jet Black

1 set



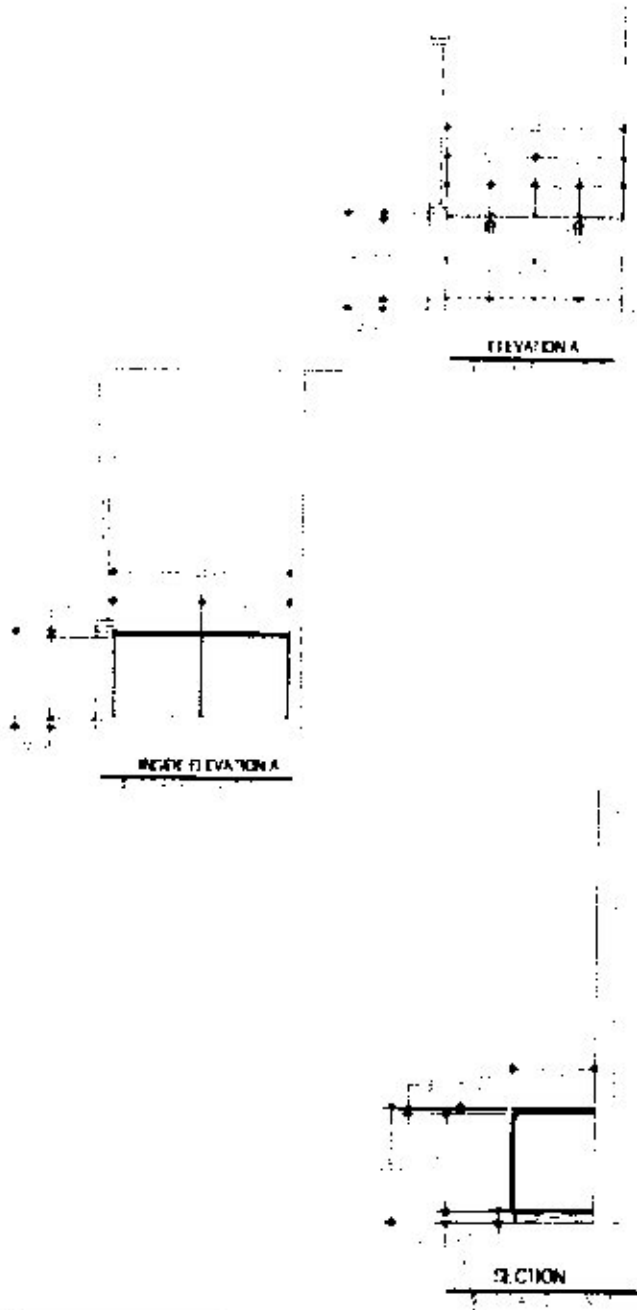

30	<b>PANTRY – HR OFFICE</b> <ul style="list-style-type: none"> <li>▪ Marine Plywood Machine Pressed, 3/4" Thick</li> <li>▪ Plastic Laminated, Wood Grain</li> <li>▪ Granite Top, Jet Black</li> </ul>	1	set
----	---	---	-----





KEY PLAN

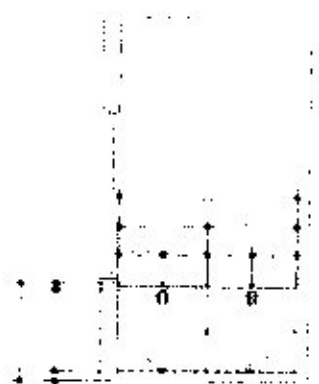

ELEVATION A



REAR ELEVATION A

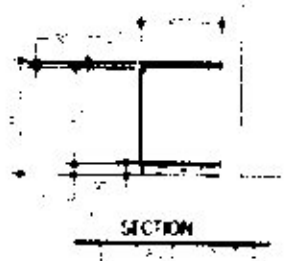

31 **PANTRY - ACCOUNTING OFFICE**

- Marine Plywood Machine Pressed, 3/4" Thick
- Plastic Laminated, Wood Grain
- Granite Top, Jet Black

1

set

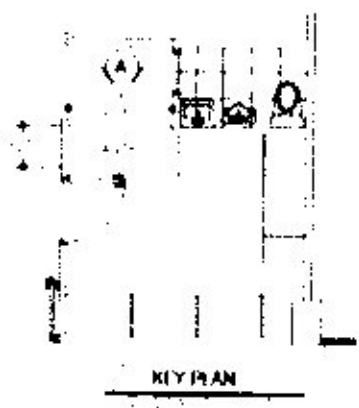

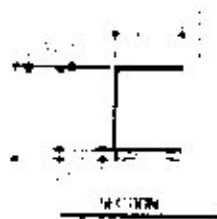
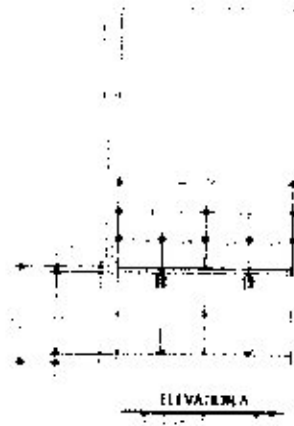

**PANTRY - PLANNING OFFICE**

- Marine Plywood Machine Pressed, 3/4" Thick
- Plastic Laminated, Wood Grain
- Granite Top, Jet Black

1

601

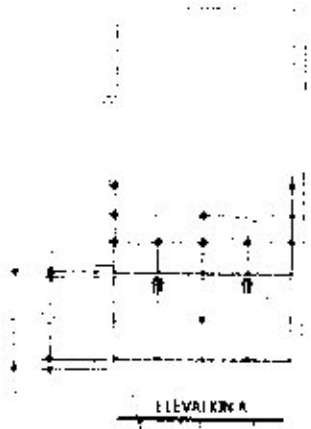
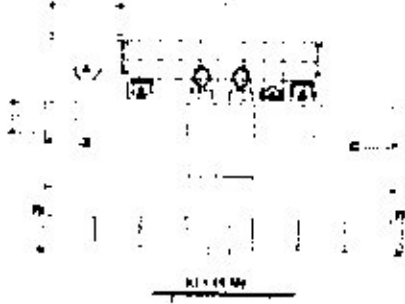

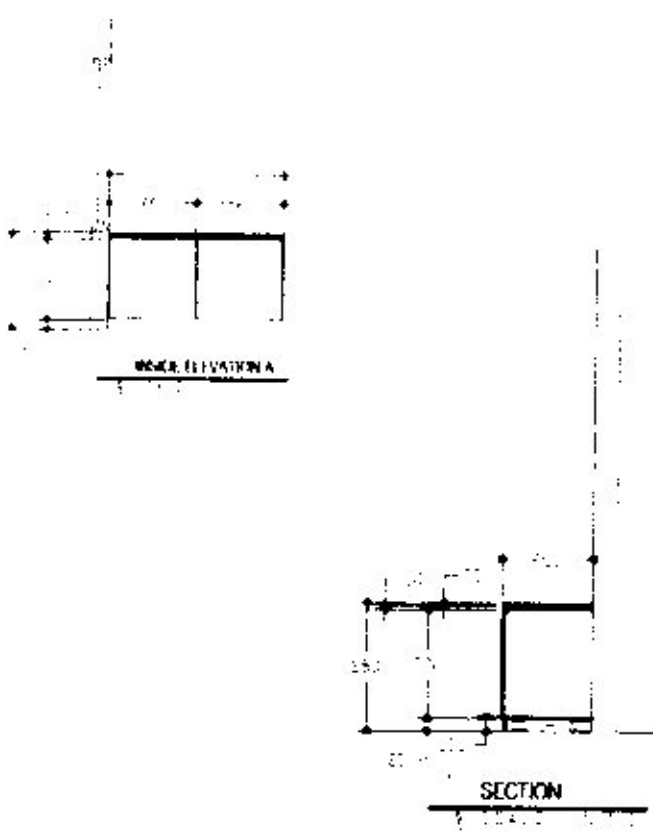
	 <p>FRONT ELEVATION</p> <p>SECTION</p>		
33	<b>PANTRY – ENGINEERING OFFICE</b> <ul style="list-style-type: none"> <li>▪ Marine Plywood Machine Pressed, 3/4" Thick</li> <li>▪ Plastic Laminated, Wood Grain</li> <li>▪ Granite Top, Jet Black</li> </ul>	1	set

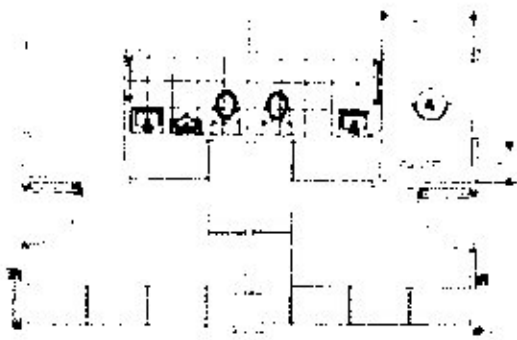

KEY PLAN

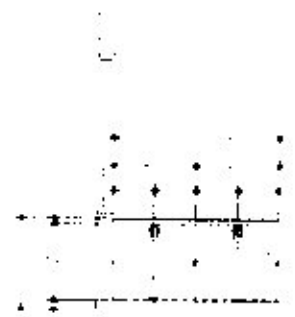

ELEVATION A

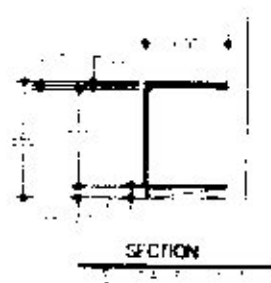
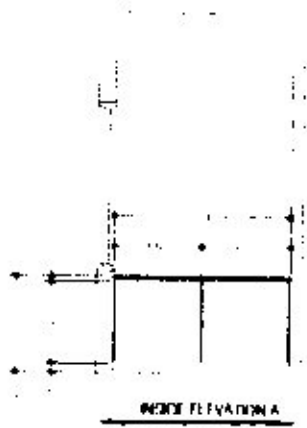

**34 PANTRY - MAYOR'S STAFF OFFICE**

**1 set**

- Marine Plywood Machine Pressed, 3/4" Thick
- Plastic Laminated, Wood Grain
- Granite Top, Jet Black

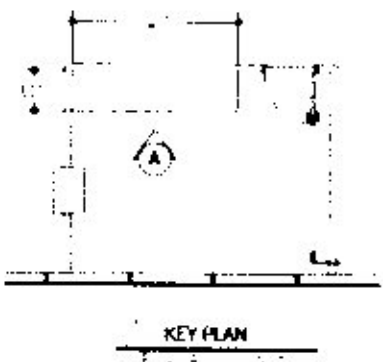

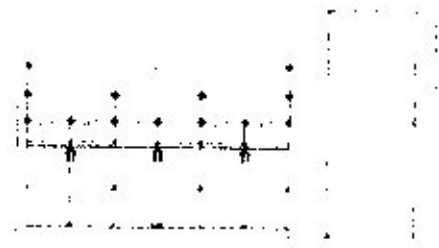

DZVYKONIA

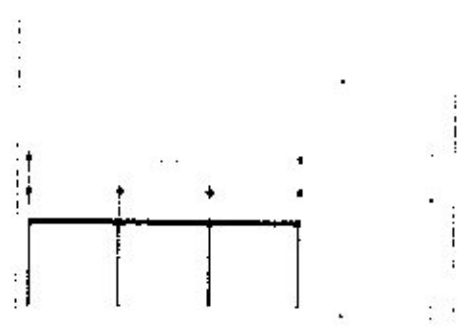

DZVYKONIA





35 **PANTRY - GSO/PESO OFFICE**

1

set

- Marine Plywood Machine Pressed, 3/4" Thick
- Plastic Laminated, Wood Grain
- Granite Top, Jet Black

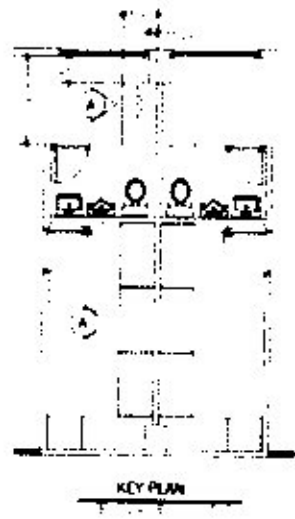

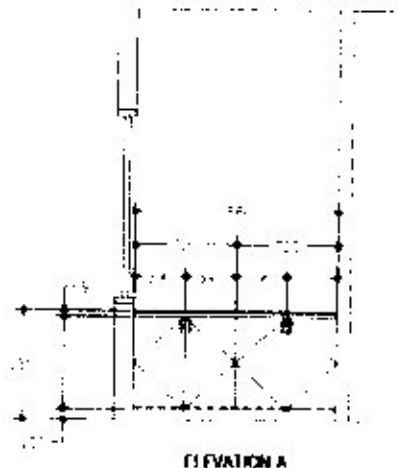

ELEVATION A

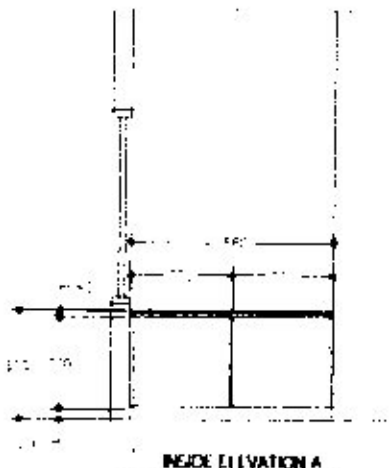

INSIDE ELEVATION A

- Marine Plywood Machine Pressed, 3/4" Thick
- Plastic Laminated, Wood Grain
- Granite Top, Jet Black



KEY PLAN

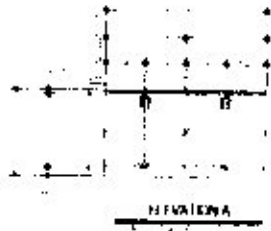

FRONT ELEVATION

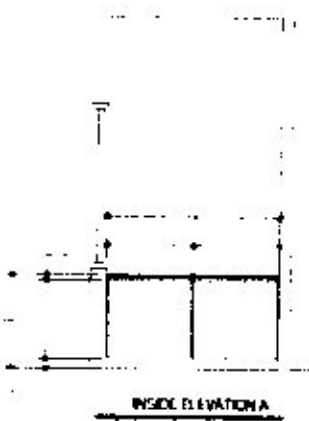

INSIDE ELEVATION A



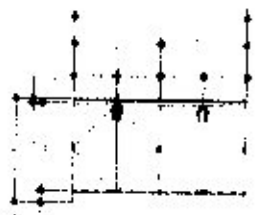

ELEVATION A

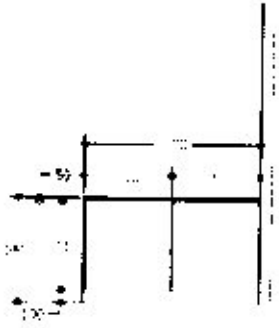

INSIDE ELEVATION A

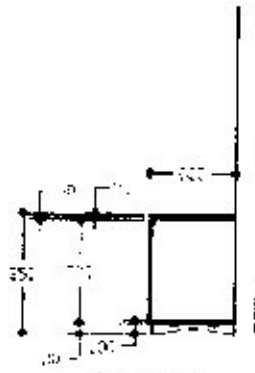

SECTION

38

**PANTRY – ASSESSOR OFFICE**

1

set

- Marine Plywood Machine Pressed, 3/4" Thick
- Plastic Laminated, Wood Grain
- Granite Top, Jet Black

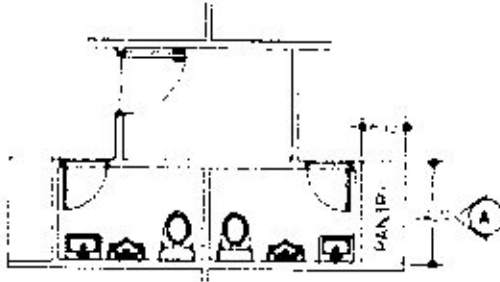

**KEY PLAN**

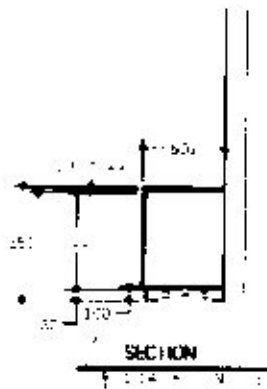

**SECTION**

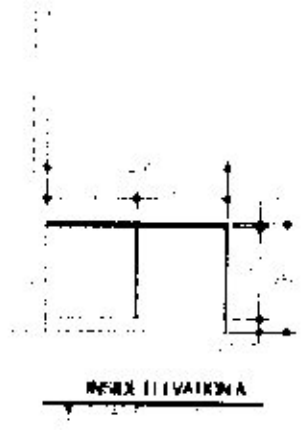
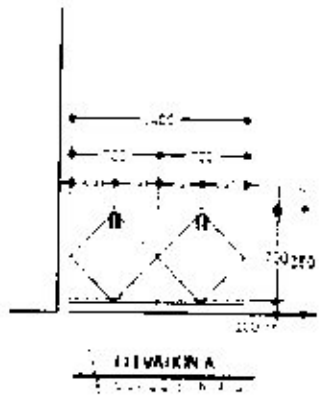

39	<b>PANTRY – CIVIL REGISTRAR OFFICE</b> <ul style="list-style-type: none"> <li>▪ Marine Plywood Machine Pressed, 3/4" Thick</li> <li>▪ Plastic Laminated, Wood Grain</li> <li>▪ Granite Top, Jet Black</li> </ul>	1	set
----	--	---	-----



KEY PLAN

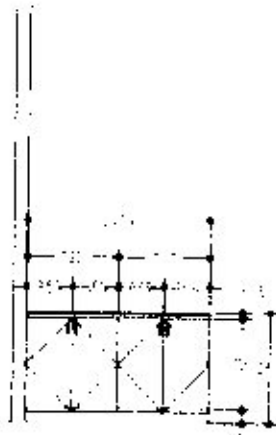

ELEVATION A



INSIDE ELEVATION A



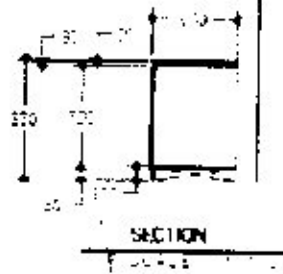

40 PANTRY - AGRICULTURE OFFICE

1

set

- Marine Plywood Machine Pressed, 3/2" Thick
- Plastic Laminated, Wood Grain
- Granite Top, Jet Black

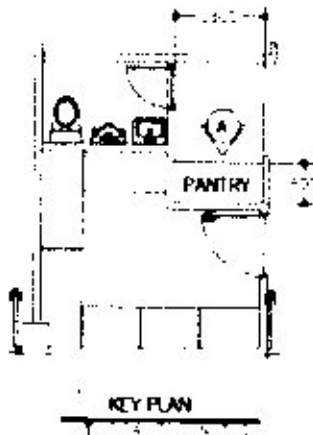

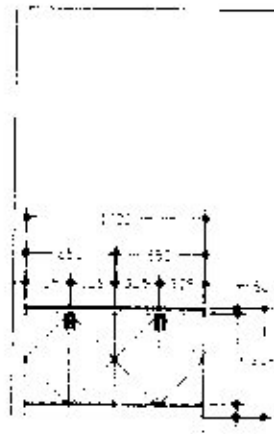

ELEVATION A



INSIDE ELEVATION A

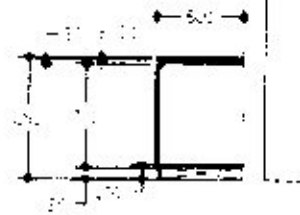

SECTION

41 PANTRY - MSWD OFFICE

- Marine Plywood Machine Pressed, 3/4" Thick
- Plastic Laminated, Wood Grain
- Granite Top, Jet Black

1

set

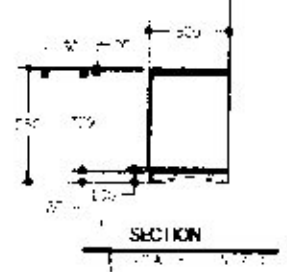
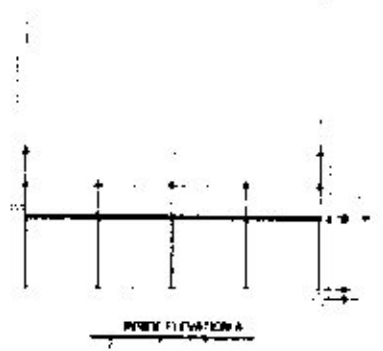
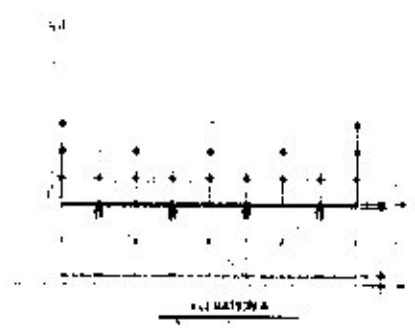
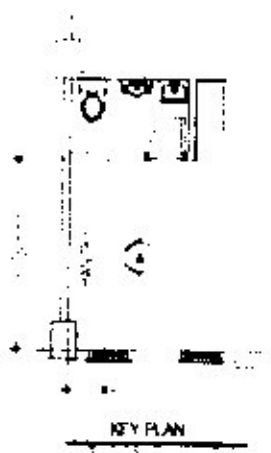

42 TRANSACTION TABLE (1-seater)

8 set

- Table Top in HPL Finish + PVC Edgebands
- White Metal Leg Base (Table divider and wire box are not included)
- Size: 1200W x 600D per table

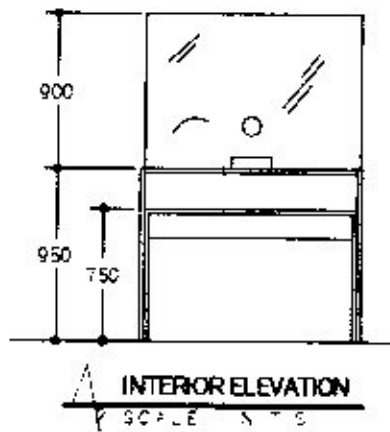
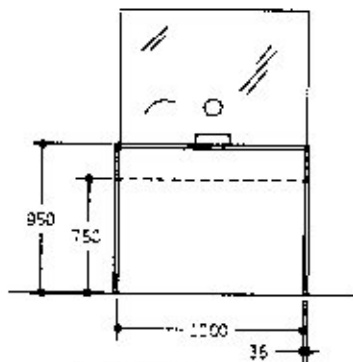
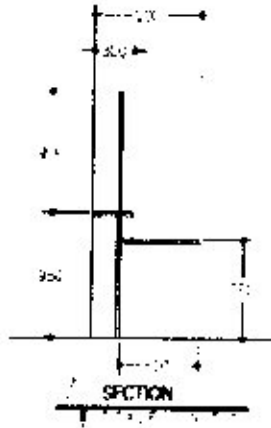
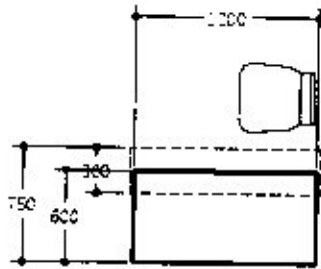

- Table Top in HPL Finish + PVC Edgebands
- White Metal Leg Base (Table divider and wire box are not included)
- Size: 1200W x 600D per table

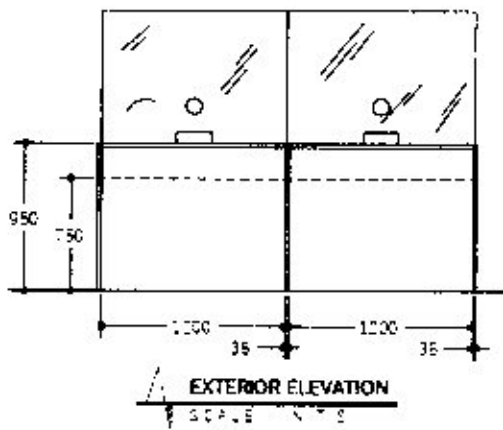
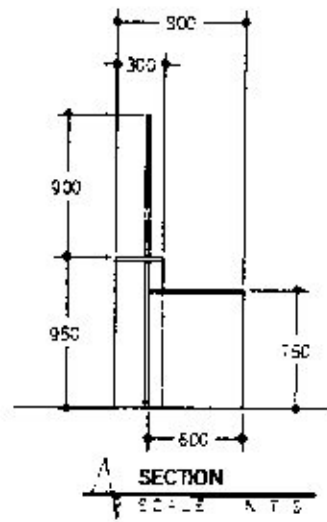
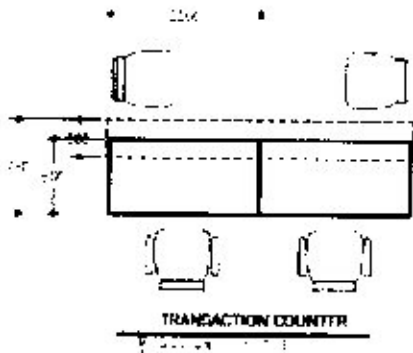

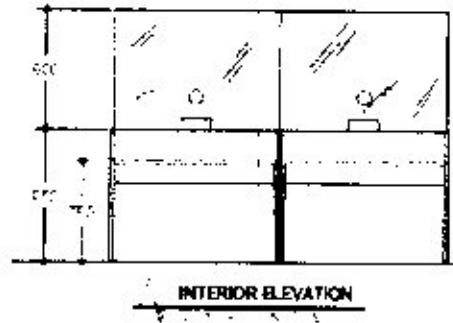

44 TRANSACTION TABLE (3-seater)

1

set

- Table Top in HPL Finish + PVC Edgebands
- White Metal Leg Base (Table divider and wire box are not included)
- Size: 1200W x 600D per table

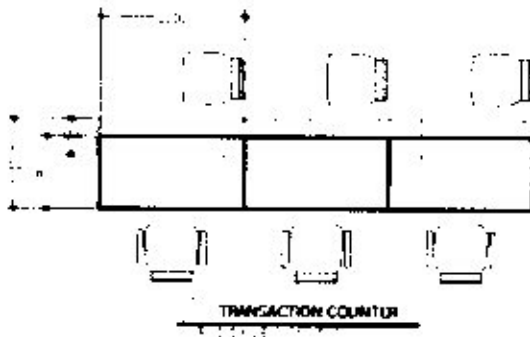

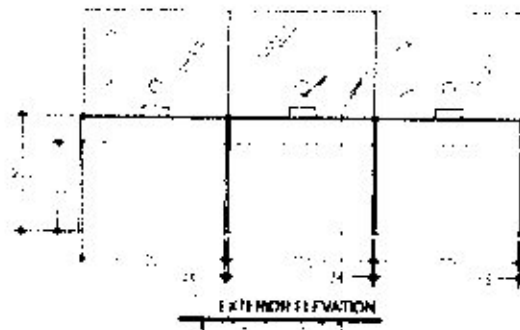
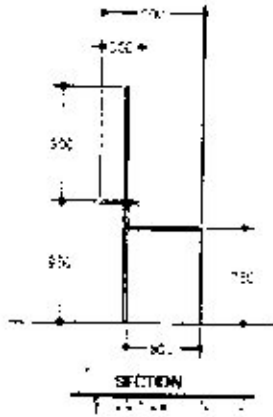

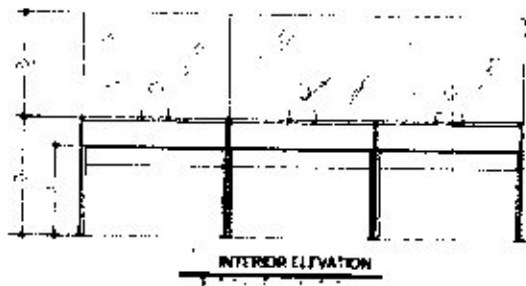

45 **TRANSACTION TABLE (5-seater)**

- Table Top in HPL Finish + PVC Edgebands
- White Metal Leg Base (Table divider and wire box are not included)
- Size: 1200W x 600D per table

2

set

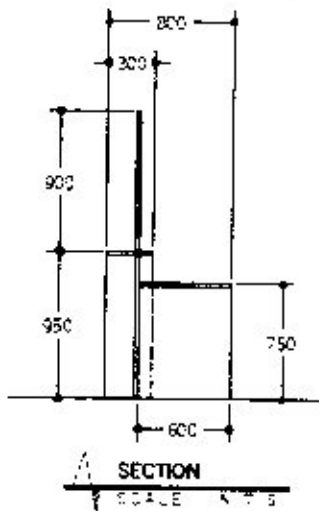
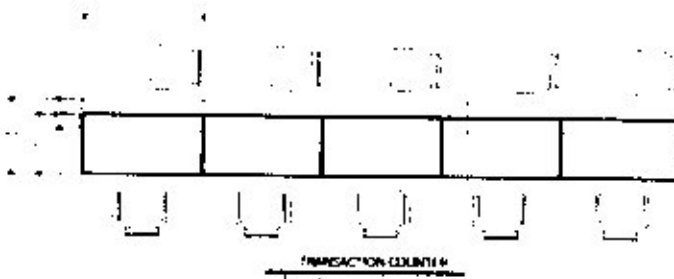



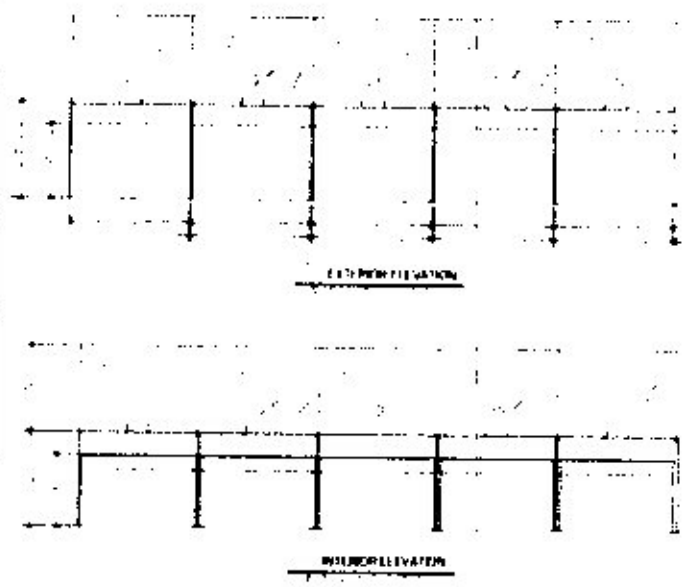

46 VAULT ROOM ENCLOSURE

1

Unit

- Rockwool Board Insulation, 2" Thick
- Hardflex Board Paint Finish
- Metal Stud Gauge 0.5mm

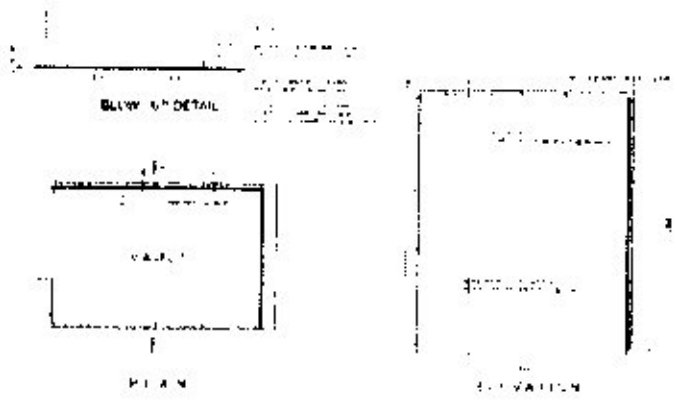

47	<p><b>Mayor's Desk</b></p> <ul style="list-style-type: none"> <li>▪ Electric Sit-stand Executive Desk with Customized Cabinet</li> <li>▪ Marine Plywood ¾" Thick</li> <li>▪ Plastic Laminate, Wood Grain</li> <li>▪ Plastic Edging</li> <li>▪ Powdered Steel Frame</li> </ul> 	1	unit
48	<p><b>Mayor's Chair</b></p> <ul style="list-style-type: none"> <li>▪ Black PU Leather</li> </ul> 	1	Unit

49	<b>Mayor's Visitor Chair</b> <ul style="list-style-type: none"><li>• Black PU Leather</li></ul> 	1	Unit